

ACCURON[®] 7100

CARTRIDGE METERS

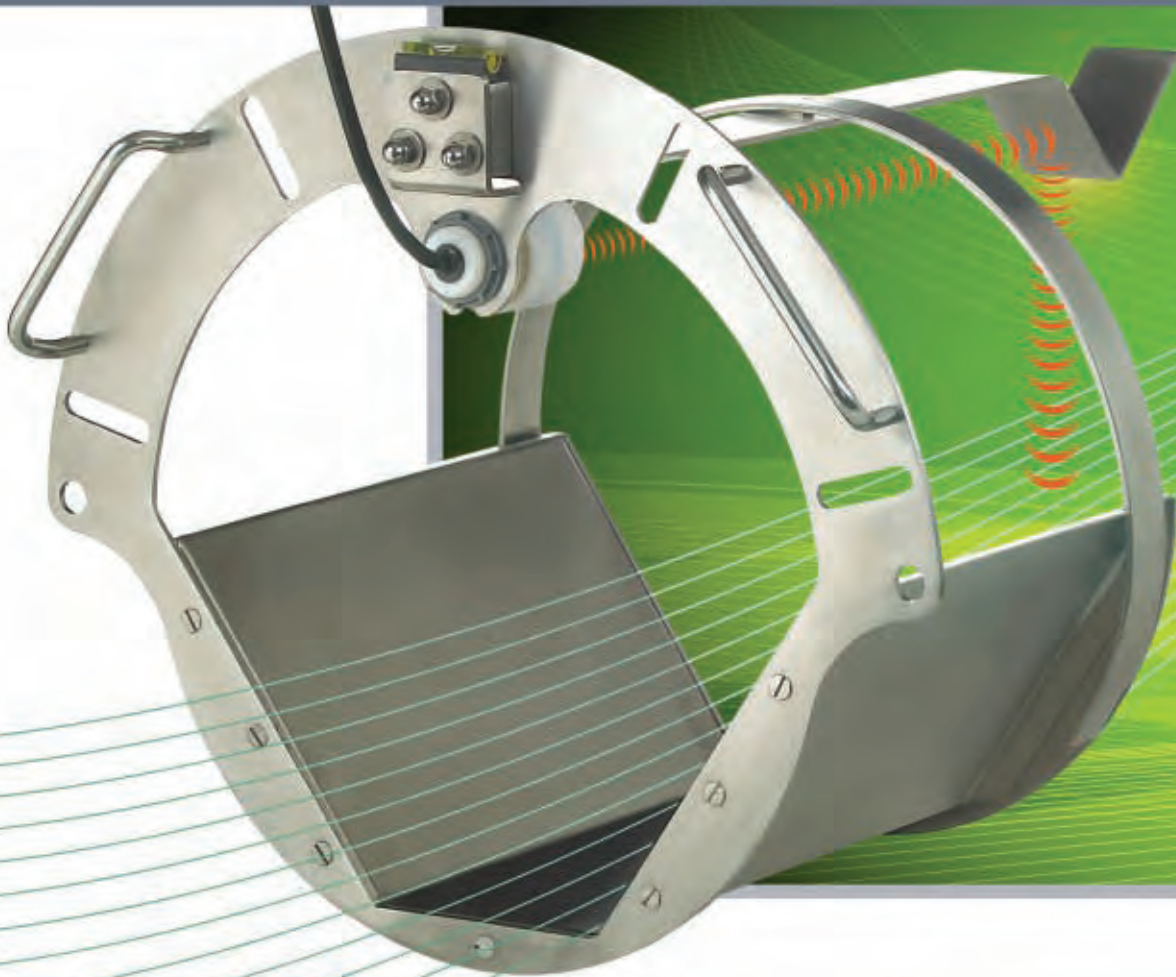

Field Ready High Performance Cartridge Meters



Eastech eliminates the high cost of flume installation, sensor mounting and field programming.

Eastech design engineers have successfully combined three separate products; a trapezoidal flume, an ultrasonic level sensor, and a mounting bracket into a fully integrated sewer flow measurement system meeting the design standards of the U.S. Bureau of Reclamation.

Engineering and plant personnel may now specify an extremely reliable and cost efficient system to monitor and measure flow in a single assembly. The Accuron Cartridge Meter (pat. pend.) shifts the responsibility of installed accuracy from the field to the factory. The added labor and expense of field programming, precise sensor alignment and costly flume installation is totally eliminated.

FULLY OPERATIONAL IN 30 MINUTES

The Accuron Cartridge Meter is a single factory integrated unit, designed for 30 minute field installation and validation.

GUARANTEED INSTALLED ACCURACY

Accuracy is guaranteed through precision factory alignment and calibration of each level sensor/flume combination. Trapezoidal flumes are designed by utilizing proven WinFlume equations developed by the U.S. Bureau of Reclamation.

IMMEDIATE 40% COST SAVINGS

Individual components are fully integrated into a single modular unit, thereby eliminating the added labor and expense of flume installation, sensor mounting and field programming. (See page 5)

MAINTENANCE FREE

By utilizing "above the flowstream" ultrasonic level sensors, the risk and expense associated with repetitive confined space entry due to fouled submerged sensor problems is now eliminated.

SINGLE RANGE FLOW TECHNOLOGY

Accuracy: $\pm 3\%$ of actual rate
Turndown Ratio: 60:1

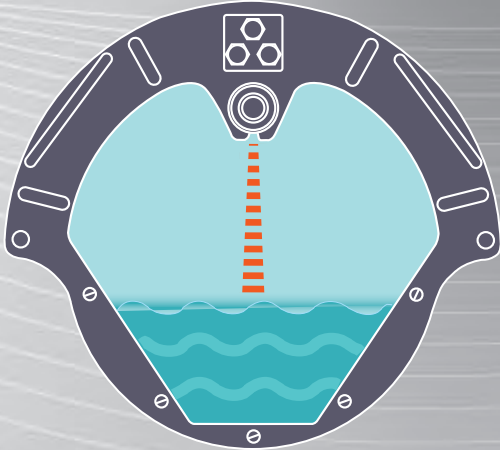

The volume of flow is consistently measured by an extremely reliable stainless steel trapezoidal flume/Teflon level sensor combination utilizing proven flume equations developed by the U.S. Bureau of Reclamation.

PRE-SIZED

Quick and simple to install, each fully integrated field ready cartridge is pre-sized and pre-programmed for its specific sewer application. Gasketed and manufactured of corrosion resistant 304 stainless steel, cartridges are installed within minutes. Integrated stainless trapezoidal flumes are accordingly sized for each specific pipe dimension and designed to operate efficiently from their full maximum flow capacity to a minimum turndown ratio of 60:1.

PRE-ALIGNED

A non-contact Teflon ultrasonic "above the flowstream" level sensor and stainless steel trapezoidal flume are precision factory pre-aligned while encased within the cartridge. Installed accuracy is guaranteed. An on-board level assures proper perpendicular alignment of the Accuron® cartridge with the piping system in which it resides.

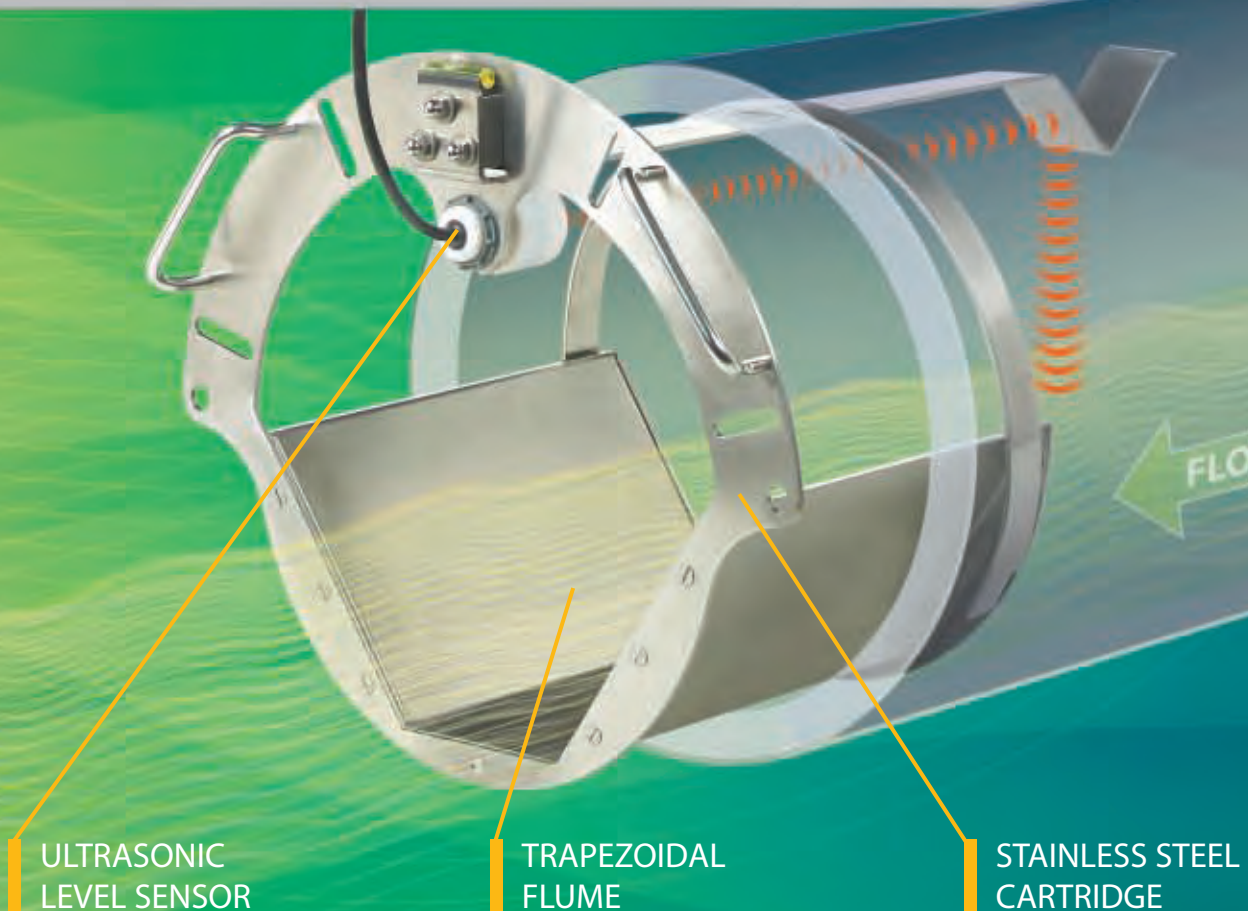

ULTRASONIC
LEVEL SENSOR

TRAPEZOIDAL
FLUME

STAINLESS STEEL
CARTRIDGE

FULLY INTEGRATED TRAPEZOIDAL FLUME

ACCURACY: ±1-5% of actual rate
TURNDOWN RATIO: 60:1

Accurate and reliable measurement of flows in municipal sewer systems is essential for effective management of routine wastewater operations. The conventional solution, an independent flume, is often expensive, time consuming to install and disruptive to existing operations. To eliminate this problem, Eastech has integrated a trapezoidal flume within the design of the Cartridge meter.

Each flume is correctly sized and pre-programmed for the application, and precisely aligned with a level sensor prior to field installation. This field-ready system provides the confidence that every flow monitoring device is installed correctly and accurately.

MAXIMUM FLUME FLOW RATE

NOMINAL PIPE SIZE	GPM
4"	14
6"	45
8"	80
10"	150
12"	240
15"	420
18"	660
21"	980
24"	1360

ULTRASONIC LEVEL SENSOR

ACCURACY: 0.02"

The overall accuracy of an ultrasonic open channel flowmeter is dependent upon conversion of level measurement to flow. Since the Accuron employs IEEE 754 single floating point precision in all of its computations, an error of less than 0.0000005% is introduced during the level to flow conversion. Accuron® ultrasonic level sensors are housed in a Nema 4,4x submersible Teflon® enclosure. The sealed vibration – isolated enclosure additionally provides for reduced microphonism in structurally noisy installations.

Each level sensor features low electrical impedance and an enhanced signal-to-noise ratio that produces a strong clean signal over a wide range of environmental temperatures.

LEVEL SENSOR SPECIFICATIONS

Environmental Rating	Submersible Nema 4, 4X
Sensor Housing	Teflon® (Resin Filled)
Temperature	-40° to 158°F (-40° to 70°C)
Accuracy	± 0.02" or ±0.05% of target distance
Standard Cable Length	30ft.
Warranty	18 months

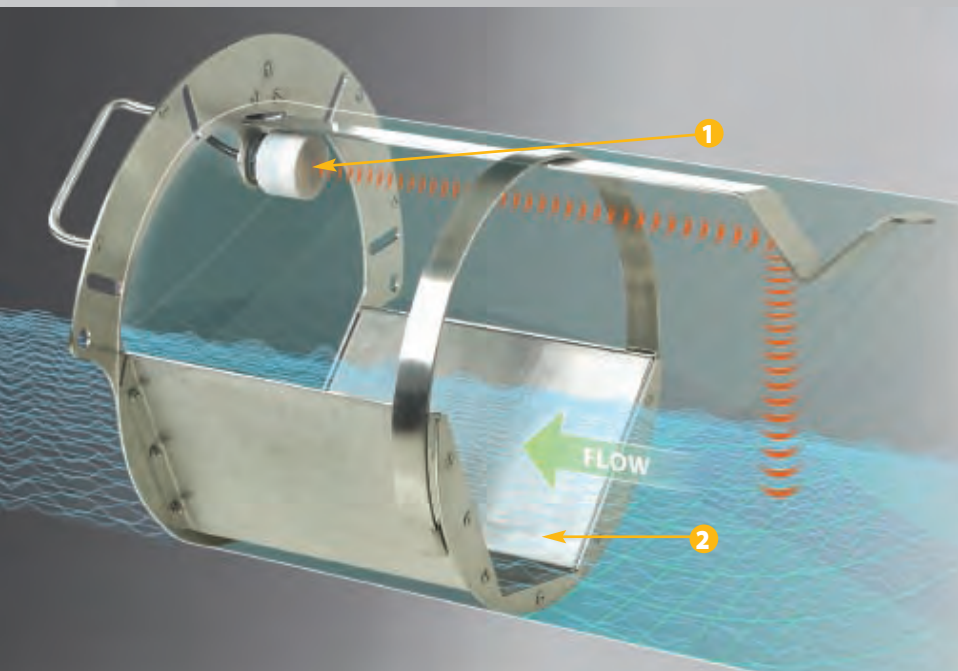

1 ULTRASONIC LEVEL SENSOR

Accuron level sensors are accurate within ±0.02" and were found to be the only sensor to "successfully penetrate 20cm of dish soap foam" in a five year study sponsored by the U.S. Bureau of Reclamation (ITRC Report No. R99-002).

2 TRAPEZOIDAL FLUME

Capable of measuring very low flows, the trapezoidal cross-section provides for an extremely wide measurement range while the flat bottom design effectively clears sediment and easily passes floating debris (EPA/600/R-01/043).

INSTALLATION COST BENEFITS



CONVENTIONAL METHOD



ACCURON®

COMPARATIVE COST ANALYSIS w/ FLOWMETER

	CONVENTIONAL METHOD			ACCURON®			
	6" Pipe	12" Pipe	18" Pipe	6" Pipe	12" Pipe	18" Pipe	
Flowmeter w/Datalogger ¹	\$1849	\$1849	\$1849	Flowmeter w/Datalogger	\$2250	\$2450	\$2750
Palmer Bowlus Flume ²	\$595	\$895	\$1290	Trapezoidal Flume	Included	Included	Included
Level Sensor Mounting Bracket ²	\$210	\$210	\$210	Level Sensor Mounting Bracket	Included	Included	Included
Installation Labor: \$70/hr/man (2 men)	\$1120	\$1120	\$1120	Installation Labor: \$70/hr/man	\$100	\$100	\$100
Total Cost	\$3774	\$4074	\$4469	Total Cost	\$2350	\$2550	\$2850
				TOTAL COST SAVINGS:	\$1424	\$1524	\$1619

¹Meter cost based on Milltronics® List Price

²Flume & bracket cost based on PlastiFab List Price

COMPARATIVE COST ANALYSIS w/ CHARTMETER (300 ft. run)

	CONVENTIONAL METHOD			ACCURON® w/ Integrated Recorder			
	6" Pipe	12" Pipe	18" Pipe	6" Pipe	12" Pipe	18" Pipe	
Flowmeter w/Datalogger ¹	\$1849	\$1849	\$1849	ChartMeter w/Datalogger	\$3450	\$3650	\$3950
Palmer Bowlus Flume ²	\$595	\$895	\$1290	Trapezoidal Flume	Included	Included	Included
Level Sensor Mounting Bracket ²	\$210	\$210	\$210	Level Sensor Mounting Bracket	Included	Included	Included
Installation Labor: \$70/hr/man (2 men)	\$1120	\$1120	\$1120	Installation Labor: \$70/hr/man	\$100	\$100	\$100
Chart Recorder ³	\$1572	\$1572	\$1572	Chart Recorder	Included	Included	Included
Install Recorder	\$100	\$100	\$100	Install Recorder	N/R*	N/R*	N/R*
330' – 3/4" Conduit ⁴	\$534	\$534	\$534	330' – 3/4" Conduit ⁴	N/R*	N/R*	N/R*
30' – 3 Cond. Wire ⁴	\$5	\$5	\$5	30' – 3 Cond. Wire ⁴	N/R*	N/R*	N/R*
300' – 2 Cond. Cable ⁴	\$555	\$555	\$555	300' – 2 Cond. Cable ⁴	N/R*	N/R*	N/R*
Labor (Electrical) ⁴	\$3030	\$3030	\$3030	Labor (Electrical) ⁴	N/R*	N/R*	N/R*
Total Cost	\$9565	\$9865	\$10260	Total Cost	\$3550	\$3750	\$4050
				TOTAL COST SAVINGS:	\$6015	\$6115	\$6210

¹Meter cost based on Milltronics® list price.

²Flume & bracket cost based on PlastiFab list Price

³Recorder cost based on Chessel® list price.

*Not Required

⁴ LABOR & MATERIAL COSTS
 3/4" Conduit
 #14-3 Conductor Wire
 #18-2 Conductor Wire

Labor
 \$6.35/ft.
 \$0.63/ft.
 \$3.05/ft.

Material
 \$1.62/ft.
 \$0.13/ft.
 \$1.85/ft.

ACCURON® 7100



Factory Programmed Flowmeters

Pre-programmed at the factory for specific customer applications, the Accuron flowmeter is a highly advanced microprocessor-based ultrasonic flow transmitter for extremely precise measurement of flow in open channels.

DATA LOGGING

The Accuron has a built-in datalogger with eight distinct channels for logging flow and totals. The storage capacity for a single channel at 5 minute intervals is 113 days. Logger data may be visually accessed on the display of the meter in pre-programmed time intervals or retrieved through a laptop or optional modem installed within the enclosure of the meter.

Daily Averages: Daily summary allows viewing of the previous eight days. This includes times, dates, averages, minimums, maximums and totals.

Logger Graph: In addition, a bar graph may be visually displayed on the Accuron. The graph will display the stored logger data in pre-programmed time intervals.

Data Retrieval: Logger data can be collected by using a laptop computer or an optional modem installed within the Accuron enclosure.

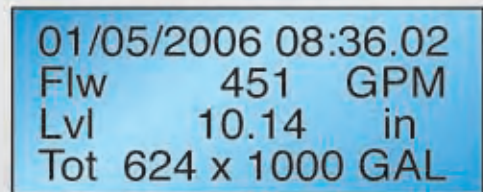

INFORMATION DISPLAY

The Accuron utilizes a 20 character four line backlit display. The main screen can be programmed to display up to eight lines of meter information such as flow, totals, time, date and relay alarm. The order of display line information is programmed to user preference. The backlit display may be programmed to be ON or OFF, or to remain OFF during a selected time interval. Display contrast is fully adjustable.

Diagnostic information is retrieved via a menu-driven self-test program capable of isolating fault parameters such as: loss of signal, 4-20 mA loop failure, logger memory full, communications error, sensor fault and open transmitter cable connection.

DATA ACQUISITION

Current Output: One 4-20 mA. Isolated, 800 ohms maximum.

Relay Outputs: Three SPDT relays available for alarm conditions.

Serial Outputs: RS-232: with Modbus protocol.

Data Logging: Eight distinct channels are available.

Communication Protocols: Modbus®, Profibus® or DeviceNet®

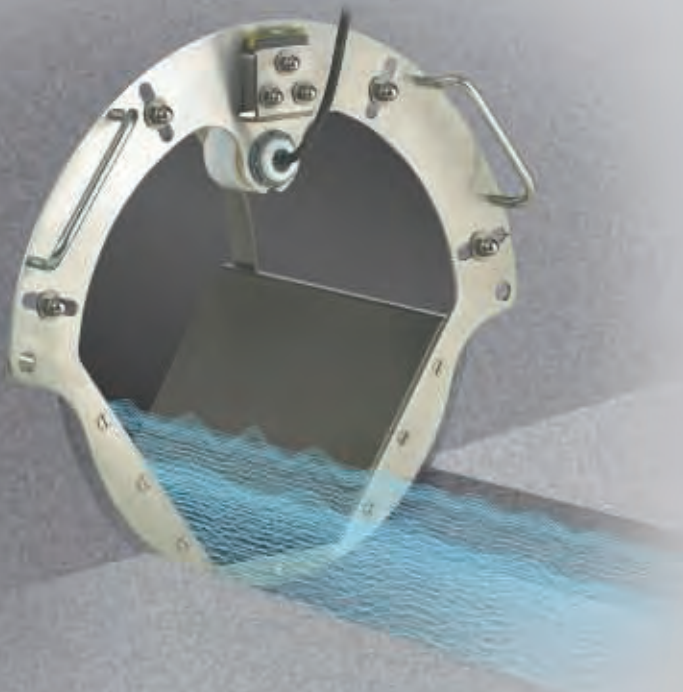

THE CHARTMETER

**A SINGLE NEMA 4, 4X UNIT
INCORPORATING A CHART RECORDER,
FLOWMETER AND DATALOGGER**

- ▶ Fully Integrated Package
- ▶ Powered by Flowmeter
- ▶ User Selectable Output Ranges and Recording Times



Accuracy	.05% Full Scale	Recording Time	24 Hour, 7 day, 31 day (user selectable)
Power Source	80/240 VAC, 50/60 Hz	Response Time	4 sec. - 60 sec. (user selectable)
	12-28 VDC @ 150 mA	Calibration	Pen Arm
Channels	One	Relays	3 SPDT (plug-in) 2.5 Amps
Recorder Display	112 x 16 Graphical	Chart Replacement Alarm	Flashing LED (Red)
Chart Rotation	User Selectable	Environmental protection	Nema 4, 4X
Chart Range	0 - 100% of Full Scale	Temperature	Standard: -4° to 158°F (-20° to 70°C)
Chart Size:	100 mm Diameter		With Heater: -40° to 158°F (-40° to 70°C)

METER TECHNICAL SPECIFICATIONS

ENCLOSURE

Standard	IP66 / Nema 4, 4X polycarbonate enclosure FM approved nonincendive, Class I, II, Div.2
Optional	Explosionproof, Aluminum Enclosure Class I, Grps. C & D, Class II, Grps. E, F, G, Div. 1 & 2
Accessories	Heater and thermostat, Door Lock

TEMPERATURE

Standard	-4° to 158°F (-20° to 70°C)
With Heater	-40° to 158°F (-40° to 70°C)

OUTPUTS

1) 4-20 mA	Analog isolated into 800 ohms max, monitored to detect open circuits. RFI and gas discharge surge protection and two fuses.
Relay Alarms	3 SPDT (plug-in) 2.5 Amps
RS-232 Serial Port	1200-38400 Baud, Modbus RTU
Network Protocols	Modbus, Profibus or DeviceNet
DC Power Out	12 VDC. 100mA maximum

DISPLAY

Backlit LCD	4 Line x 20 character (contrast control)
-------------	--

POWER

Wattage	12
Voltage	80/240 VAC, 50/60 Hz / 12-28VDC @ 150 mA.

DATA LOGGING

Non-volatile flash memory, storage of up to 32768 records.

PREVIEW® FIELD VALIDATION

A Preview® Validation Pac is provided with every Accuron®. This allows for immediate field confirmation (up to 4 hours) of proper installation, programming, and operational integrity prior to hook-up of permanent power.

By simply connecting the Preview® Validation Pac to the input terminals of the meter, correct sensor wiring, installation, programming and data display can be confirmed and datalogged.



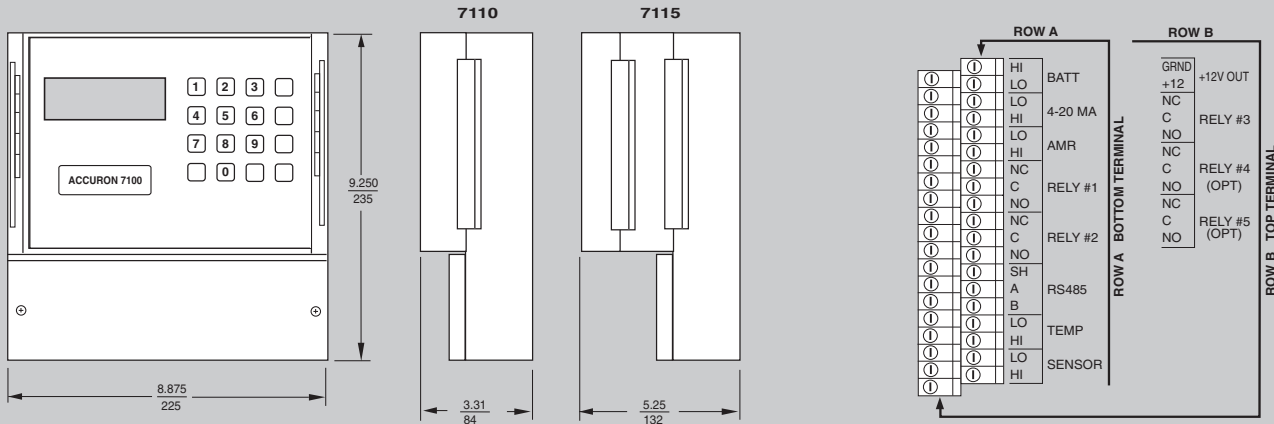

DIMENSIONS

WIRING SCHEMATIC



SUGGESTED SPECIFICATIONS: An ultrasonic microprocessor-based Cartridge Meter shall be installed at the location on the plans in accordance with the manufactures recommendation. A field-ready _____ (pipe size) stainless steel cartridge, containing a stainless steel trapezoidal flume/ultrasonic level sensor combination shall be provided with each flowmeter. The IP66/Nema 4,4X flowmeter (or Chartmeter) shall be factory programmed for the specific application and be provided with a datalogger integral to the electronics. The Cartridge Meter must be capable of field validation prior to installation of permanent power. The unit shall be Model Accuron 7100 as manufactured by Eastech Flow Controls, Tulsa, OK or equal.

ORDERING GUIDE

CARTRIDGE	METER	NOMINAL PIPE SIZE	PIPE MATERIAL	PIPE SCHED.	PIPE CONST.	SENSOR CABLE	OPTIONS	PROGRAM	DATA RETRIEVAL
 Stainless Steel Cartridge Trapezoidal Flume Level Sensor	METER 10	4" (14*)	Concrete K	10 R	Lined LN	30 ft W	Heater & Thermostat B	Gal./Min. A	Modem (phone line) M
		6" (45*)	Ductile L					Cu. Ft./Sec. H	Profibus E
		8" (80*)	Cast Iron M	40 S	Unlined UL	50 ft. X	Keylock C	Mil. Gal./Day J	Device-Net F
		10" (150*)	Carbon Steel N			100 ft. Y	Splice Kit D	Lit./Sec. K	
		12" (240*)	PVC P		80 T			Gal./Hr. L	
		15" (420*)	Clay Q			200 ft. Z		Other (please specify)	
		(N) 18" (660*)				(Over 200 ft. please specify)			
		(N) 21" (980*)	Other (please specify)						
		(N) 24" (1360*)							
		CHARTMETER 15							
	 Nema 4,4X • IP66 1-4-20mA • RS232 3 Relays • Datalogger Circular Chart 1 Day • 7 Day • 31 Day (please specify)								

*Max. Flume Flow Rate (GPM) (N)NOTE: For Cartridges larger than 15 inches please specify manhole entry size.

For Cartridge Meters larger than 24" or custom sizes, please contact factory.

Ordering Example: Accuron Cartridge Meter, 12" pipe size, PVC, Sched. 40, 30' cable, 3 relays, programming GPM: 7110-12" – P-S-W-A

